

XL WOOD SHAVINGS

PRODUCT DESCRIPTION

XL wood shavings are made of white wood shavings having a large structure of a good quality which have been heat-treated. The shavings has a humidity level up to 50-60 % and it contains no toxins or foreign bodies. The bedding has a good moisture absorption thanks to the large flakes. A dry environment means less bacteria and fungus as they have difficulties existing there. The wood shaving are suitable for horses with sensitive airways.



100 % dust extracted

Heat-treated

Highly absorbent

100 % biodegradable

Reduction of dunghill

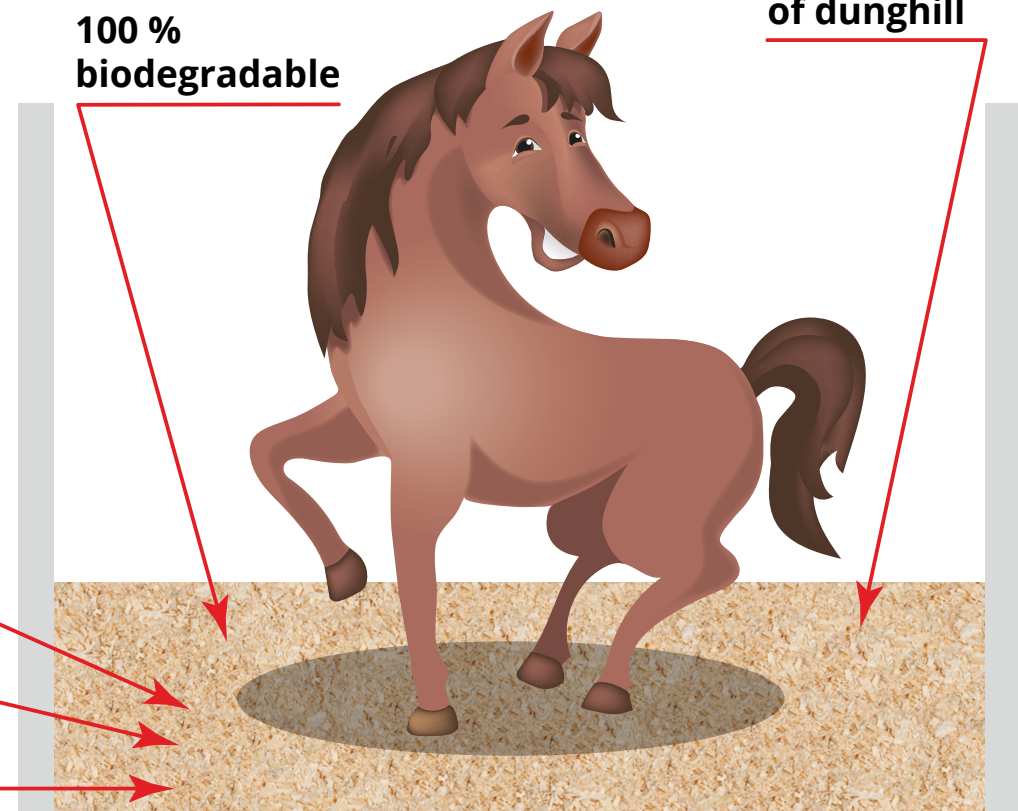

HOW TO USE

- 1 Clean and disinfect the box



- 2 When starting up, 3-5 bales of shavings are spread evenly in the box (at a standard box of approx. 12 m²)

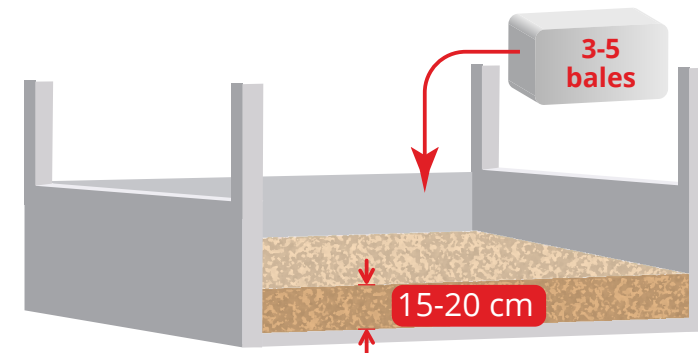

- 3 To ensure a hygienic bed, wet droppings should be removed daily

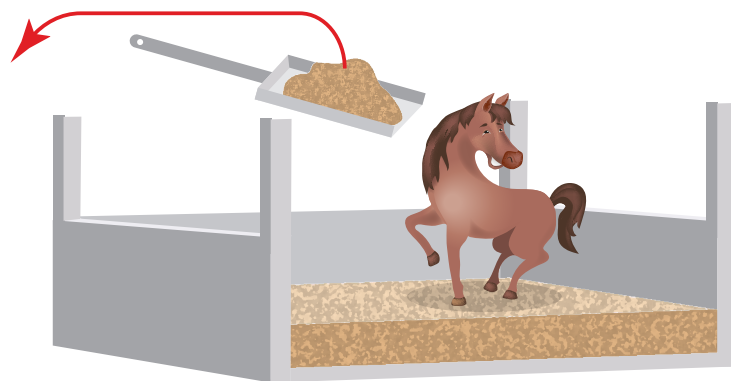

- 4 More shavings should be added when necessary to maintain a suitable depth of roughly 15 cm (weekly maintenance will require 1 or 2 bales)

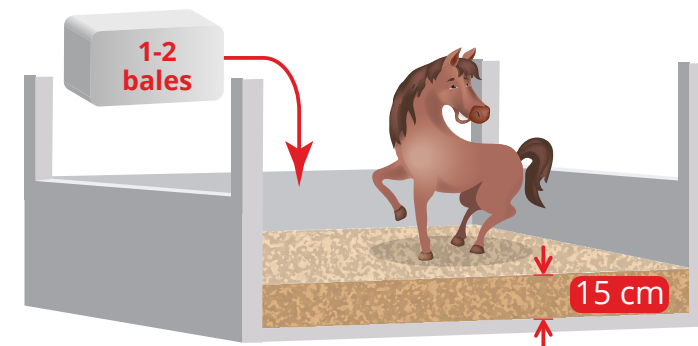

LOGISTICS

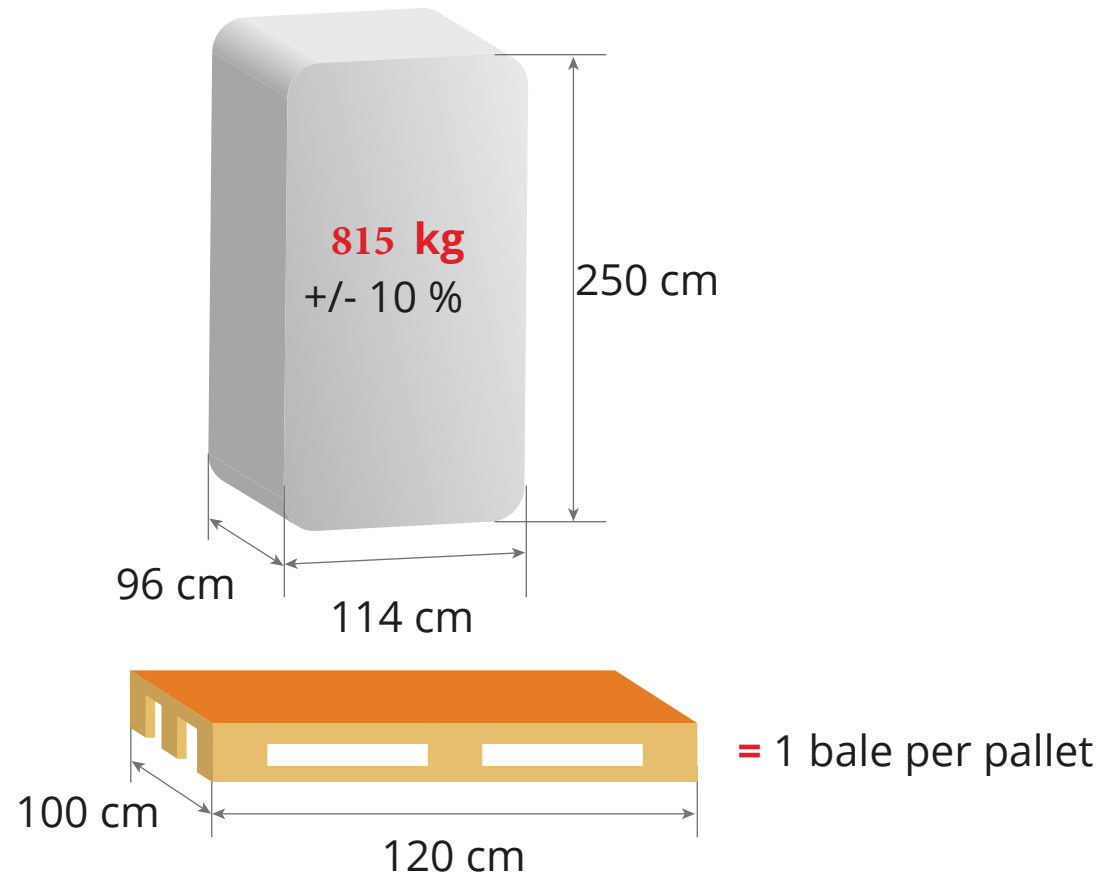

LOGISTICS



40'HC CONTAINER



TENT TRUCK